

*Received: August 15, 2015, reviewed, accepted: September 14, 2015*

## **SIMULATION OF A HIGH-PRESSURE WATER JET STRUCTURE AS AN INNOVATIVE TOOL FOR PULVERIZING COPPER ORE IN KGHM POLSKA MIEDŹ S.A.**

Przemysław BORKOWSKI<sup>1\*</sup>, Seiji SHIMIZU<sup>2</sup>, Guoyi PENG<sup>2</sup>, Yasuyuki OGUMA<sup>2</sup>

<sup>1</sup>KGHM Cuprum Research & Development Centre, Wrocław, Poland.

<sup>2</sup>Fluid Engineering Laboratory, Nihon University, Koriyama, Japan.

---

**Abstract:** Effective comminution of copper ore for further processing during flotation is still a challenge, both as a technological problem as well as for the high energy costs of such processing. A high-pressure water jet is one alternative method of preparing copper ore for final flotation, causing distinct enlargement of the surface of micronized particles, which could be profitable for copper production. As a consequence of such innovative processing, particles of copper ore become micronized, ensuring grain fractions directly useful for flotation at the exit of the pulverizing apparatus (the hydro-jetting mill). The paper presents some results of simulation as well as describing an analysis of the phenomena occurring inside the high-pressure water and abrasive-water jets of specific structures, elaborated in the aspect of developing hybrid jets of maximum erosive efficiency, potentially useful for effective pulverization.

---

**Keywords:** copper ore, comminution, high-pressure water jet, simulations

### INTRODUCTION

The usefulness of high-pressure water and abrasive-water jets, effective tools for pulverizing or comminuting e.g. minerals and brittle materials, depends mainly on the method and conditions of generating the water jet, as well as in the method and in the number of additional abrasive grains and, consequently, the method and conditions of such addition.

---

\* Corresponding authors: pborkowski@cuprum.wroc.pl (P. Borkowski)

The pulverizing of materials finds a wide range of applications in many branches of processing and, as a result, aims at ultimately producing, e.g. mineral aggregates of respective grain sizes (Bielecki, 2013; Borkowski P., 2010; Borkowski P. et al., 2012; Dvorský, et al. 2010, Fu, et al., 2007; Mazurkiewicz, Davey, 2002; Sitek, et al., 2012); the production of semi-finished energy products for new generation fuels (coal-water-slurries) (Borkowski P., Borkowski J., 2010; Borkowski P. et al., 2014; Borkowski P. et al., 2014; Bortolussi et al., 1994; Cui et al., 2006; Cui et al., 2008; Galecki et al. 1988; Mazurkiewicz, Vašek, 1997), or just for grain preparation as a final step preceding the flotation of minerals. However, one should keep in mind that the last-mentioned processes are the most energy consumptive ones (Borkowski P., 2009; Borkowski P., Borkowski J., 2009; Neikov, 2009; Shimizu et al., 2007; Shimizu et al., 2009).

A high-pressure water jet is one alternative method of preparing copper ore for final flotation. As a consequence of such innovative processing, particles of copper ore become micronized, ensuring at the exit of the comminuting apparatus (a hydro-jetting mill) grain fractions directly useful for the process of flotation. The structure of the surface of the micro-particles is an important feature of this way of preparing the feed as a consequence of the different mechanism of comminution compared to traditional mechanical methods (Bielecki, 2013). Surface-specific expansion takes place as a result of the hydrodynamic influence of the high-pressure water jet, ensuring a decidedly better mechanical 'opening' of the grain's structure and, consequently, better conditions for chemical penetration of reagents during foam flotation.

One should have in mind however that the building of a high-efficient hydro-jetting mill for successive pulverization of copper ore requires knowledge of the mechanisms of generating a high-pressure work jet. Having the above in mind, the paper presents some results of simulation research as well as describing an analysis of the phenomena occurring inside high-pressure water and abrasive-water jets of specific structures, realized in the Fluid Engineering Laboratory in Japan.

#### HYDRO-JETTING COMMINUTION OF COPPER ORE

After thorough analysis of several American and Chinese constructions of hydro-jetting mills (Fang, Gong, Chen, 1999; Ito et al. 2009; Ito et al. 2011; Mazurkiewicz, 2001, Peng et al., 2009; Shimizu, 2006), our own original prototype was built (Bielecki, 2013). Such a vertical prototype is shown in Fig. 1a. Comminution of the feed takes place as the synergetic influence of the high-pressure water jet and a dynamic stroke of particles become disintegrated. The exemplary effects of the surface expansion of the copper ore occurring in such circumstances, potentially useful for increasing copper flotation, is presented in Fig. 1b.

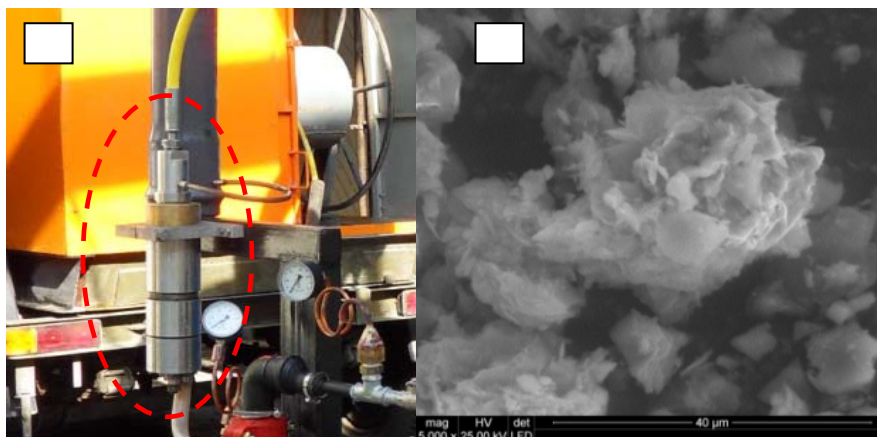

Fig. 1. High-pressure jetting mill of own construction (a) and exemplary SEM picture of carbonated copper ore surface amplification, comminuted with water pressure of 100 MPa (b)

Such a jetting mill ensures the possibility of comminuting materials in the range of working water pressure 50÷300 MPa, and a water consumption range of 0.2÷0.5 dm<sup>3</sup>/s. The given prototype allows the use of feed materials up to 2 mm in diameter, ensuring a distinctly increased efficiency of micronization, a range of 50 g/s (Borkowski P. et al., 2014; Borkowski P. et al.\*, 2014).

Having in mind the most recent research (Ito et al. 2009; Ito et al. 2011) including our own work (Borkowski P., 2010), it is very important to generate a quality jet. Knowing the jet's behavior as well as proper dosing of the copper ore feed, ensures adequate movement of the copper particles inside the work chamber of the hydro-jetting mill. All of the above influence the grade and quality of the mineral material being comminuted, and make it possible to better design innovative technologies for pulverizing copper ore.

## RESEARCH METHODOLOGY

Research analyzing the phenomena that occur inside both water- and abrasive-water jets was possible thanks to the use of a specialized apparatus possessed by the Fluid Engineering Laboratory in Japan. A new quality of research has been conducted thanks to this modern technique of measurement. However, it was necessary to design and to build an adequate measuring track giving the chance to conduct some experiments for modeling super-speed processes occurring inside the water jet.

## MEASURING TRACK

In order to conduct simulations in conditions close to the natural ones occurring inside a hydro-jetting mill during generation of a high-pressure water jet, it was necessary to set up an experimental-measuring track, presented in Fig. 2.

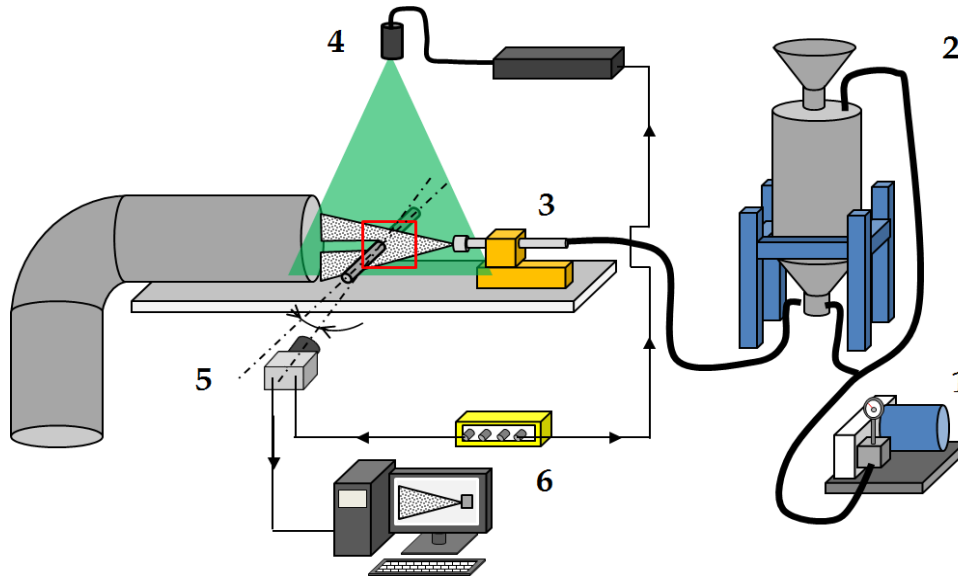

Fig. 2. Schema of measuring track for high-frequency processes recording occurring inside high-pressure water jet (1 – high-pressure water pump, 2 – device for generating ASJ (abrasive-suspensive-jet), 3 – work nozzle FanJet type, 4 – PIV (particle image velocimetry) laser system, 5 – high-speed video camera, 6 – computer)

It includes a set of apparatuses for generating a high-pressure water jet, as well as measuring devices. A high-pressure water pump (1) that generates a water jet of adequate pressure, directs it through a special hose to the generator of a suspensive jet ASJ type (2). As a consequence of the abrasive bed washing out, a three-phase abrasive-water-air jet is generated then and finally formed in a FanJet type work head (3). Such a jet is directed onto the surface of the target (Fig. 3) which stands as counterpart to the comminuting plate inside the real mill.

The contact zone of the jet and the treated material, crucial for erosion efficiency, is observed as a double-track, both using a laser PIV system (4) and high-speed video camera (5). Both these tracks record and then send out high-resolution time-lapse pictures to a computer (6) that includes dedicated software enabling analysis of the phenomena occurring both inside the jet and in the erosion zone.

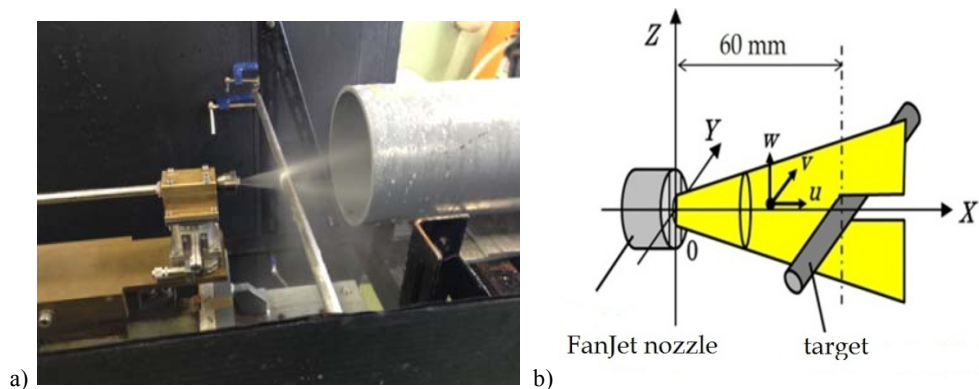

Fig. 3. Research setup for simulation of hydrodynamics occurring in a hydro-jetting mill: general view (a), schema of work zone (b)

#### LASER VISUALIZATION SYSTEM

Recording the processes inside a high-pressurized water jet can be conducted using a specialized Nd:YAG laser, LDP-100MQG type, made by Lee Laser Inc. (Fig. 4).

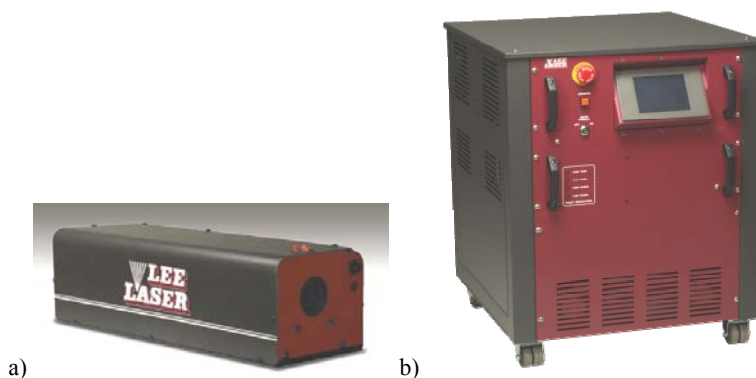

Fig. 4. General view of LDP-100MQG laser (a) and steering device (b), made by Lee Laser, Inc.

Application of the laser (usually laser impulses, frequency up to 100  $\mu$ s), along with the dedicated software type Koncerto2 by Seica Measurement Technology, enables the research of the high-speed phenomena occurring inside the turbulent flow of a high-pressure multi-phase jet. A specific example of that may be recording the movement of abrasive particles carried by the energy of the jet. The abrasive-water jet examined in this case is exposed by such a laser's electro-magnetic beam of the power of 8.0-2.4 mJ and a frequency range of 5–30 kHz. Processing of data gathered in such

way ultimately enable the rendering of time-lapse pictures of high quality into the sequence of a movie.

The software additionally enables thorough analysis of the dynamism of the inside jet, e.g. the velocities and direction of respective grains moving within the jet, which generally changes up-to-date knowledge in the scope.

#### HIGH-SPEED RECORDING OF THE JET STRUCTURE

A special high-speed Photron camera SA-NX2 type (Fig. 5) was used for recording hybrid water- and abrasive-water jets. It uses a CMOS sensor of resolution 1024 x 1024 pixels and allows recording at least 240 f/s with a 12 bit depth of field. The given exposure time is 300 ns, thanks to which the maximum speed of recording, using reduced quality, is 1.000.000. f/s. The camera cooperates in connection with laser system LDP-100MQG, controlled by dedicated Koncerto2 software, enabling synchronized recording of the time-lapse video of respective cross-sections of the hybrid jet, being overexposed throughout by a laser (Fig. 5b).

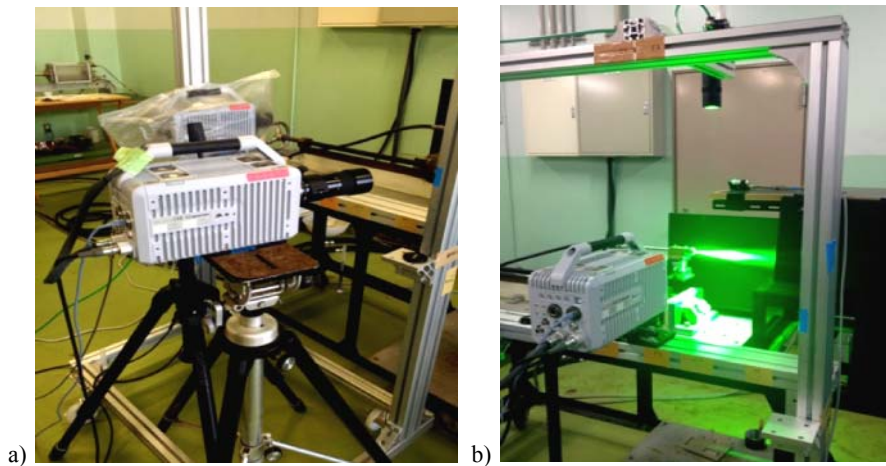

Fig. 5. High-speed camera Photron SA-NX2 type: general view (a) and during recording (b), working in the connection with LDP-100MQG laser

#### RESEARCH OF HIGH-PRESSURE WATER- AND ABRASIVE-WATER JETS

Analysis of the research results were based on mathematical methods elaborated and adopted for Koncerto2 software (Geveci, et al., 2003). Analyzing pictures, one can establish time-averaged X and Y direction components of the jet velocity given in the following formulas:

$$\overline{u(X, Z)} = \frac{1}{N} \sum_{n=1}^N u_n(X, Z), \quad (1)$$

$$\overline{w(X, Z)} = \frac{1}{N} \sum_{n=1}^N w_n(X, Z), \quad (2)$$

where:  $u_n(X, Z)$  – the X direction component of instantaneous velocity,  $w_n(X, Z)$  – the Z direction component of instantaneous velocity,  $N$  – total number of instantaneous velocity fields.

Additionally, for such analysis one should use dependencies describing respective directional components of the root-mean square components of velocity fluctuation, as stated below:

$$u_{rms} = \sqrt{\frac{1}{N} \sum_{n=1}^N [u_n(X, Z) - \overline{u(X, Z)}]^2}, \quad (3)$$

$$w_{rms} = \sqrt{\frac{1}{N} \sum_{n=1}^N [w_n(X, Z) - \overline{w(X, Z)}]^2}. \quad (4)$$

#### BASIS OF TURBULENT JET FLOW

Based on theoretical analysis, an algorithm was used enabling definition of the instantaneous velocity fields of the jet. Sample illustrations showing conducted simulations are presented in Fig. 6.

Such video frames illustrate water droplets moving along the jet (a) as well as abrasive grains (b), which substituted for copper ore in such laboratory conditions. As observation shows, particles are carried along the jet with a velocity exceeding 100 m/s, reaching the target and dispersing its kinetic energy there, to slow down the jet flow. The change of the grains' vector (direction and reversal) when in contact with the target material is also a consequence. It should be mentioned here that analogical conditions, on a different technical scale, occur also inside a hydro-jetting mill, during collision of copper ore particles with a comminuting plate made of sintered carbide. Analysis of respective parts of the picture allows observation of the relatively huge jet aeration, confirming our own previous observations (Borkowski P., 2010).

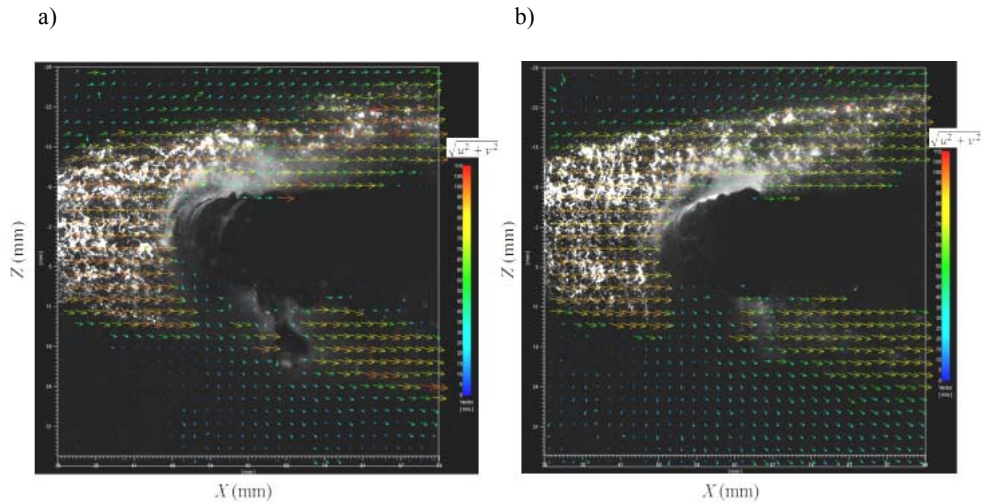

Fig. 6. Time-lapse pictures, including the net of instantaneous velocity fields of the jet given for: water jet (a) and suspensive abrasive-water jet (b). Work conditions:  $p = 50$  bar,  $SoD = 60$  mm, garnet #200

## 4.2. ANALOGIES OF JET FLOW INSIDE A HYDRO-JETTING MILL

The dynamism of the comminuted material described above can be observed much more easily after the video picture taking off and leaving the net of elementary velocity fields alone, which is described as (5) (Geveci, et al., 2003):

$$\bar{v}_{uw} = \sqrt{\bar{u}^2 + \bar{w}^2}, \quad (5)$$

where:  $\bar{v}_{uw}$  – magnitude of time-averaged velocity,  $\bar{u}$  – time-averaged velocity in X direction,  $\bar{w}$  – time-averaged velocity in Z direction.

Resultant pictures of the given procedure are presented in Fig. 7. It turns out that gross energy is carried inside the jet (i.e. mainly in the core). Increasing the distance from the work nozzle, observed along the jet, the aeration of a coherent jet takes place; striking the forehead of the target causes the droplet phase to arise, finally dispersing its energy contiguously to the target surface.

Both cases of exemplary water-air- as well as abrasive-water jet structures analyzed here, one can find analogical phenomena that decide the jet's aerial stratification in a direction perpendicular to the axial. It can be clearly observed that barely 20-30 mm distant from the axis in a perpendicular direction, the given velocities of jet layers reach only several percent of that in the axis.



This is another conclusion important for practice, informing the proper way to design an abrasive-water jet tool in order to fully use the kinetic energy accumulated in a high-pressure water jet.

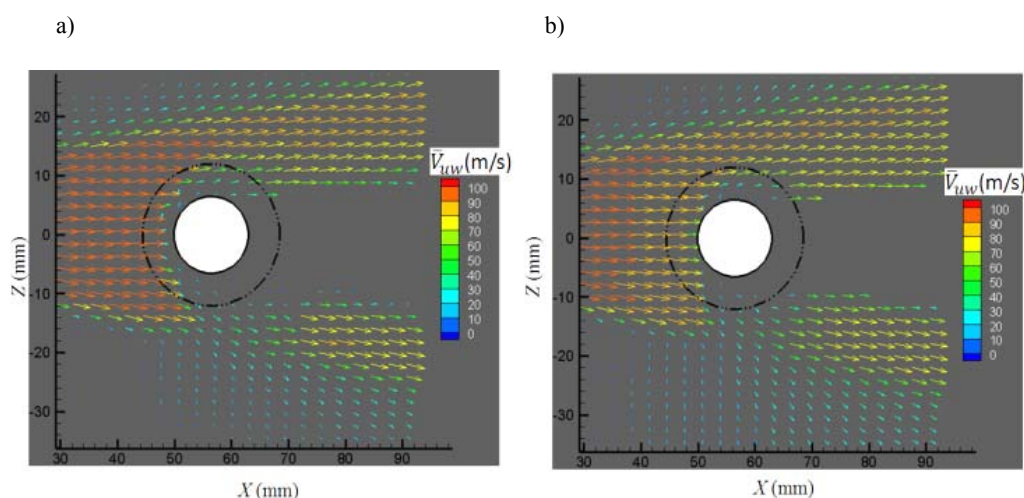

Fig. 7. Elementary velocity fields of particles  $\bar{v}_{uw}$  moving in: water jet (a) and suspensive abrasive-water jet (b). Work conditions:  $p=50$  bar,  $SoD=60$ mm, garnet #200

### 4.3. SIMULATION ANALYSIS OF JET FLOW

Some more detailed information can be concluded by observation of the pictures showing the respective directions of jet flow. For example, figure 8 shows velocity distribution fields  $\bar{u}$  presented for both water jet (a) and abrasive-water jet (b), given for horizontal component X. This is why one can observe a full velocity range of particles moving in the jet. Moreover, characteristic areas of jet intermittence can be observed, or more general formation, the lack of symmetry in respect to axis “O”.

Such effects may be caused presumably by imprecise setting of the work nozzle in one axis of the target rod. Regardless of the factual reasons for that, however, one may draw the main conclusion concerning the cumulative effect of kinetic energy and the increase of jet velocity along its axis. Thanks to this, designing proper construction of a mill needs the rule of centric sprinkling of high-energetic water jet.

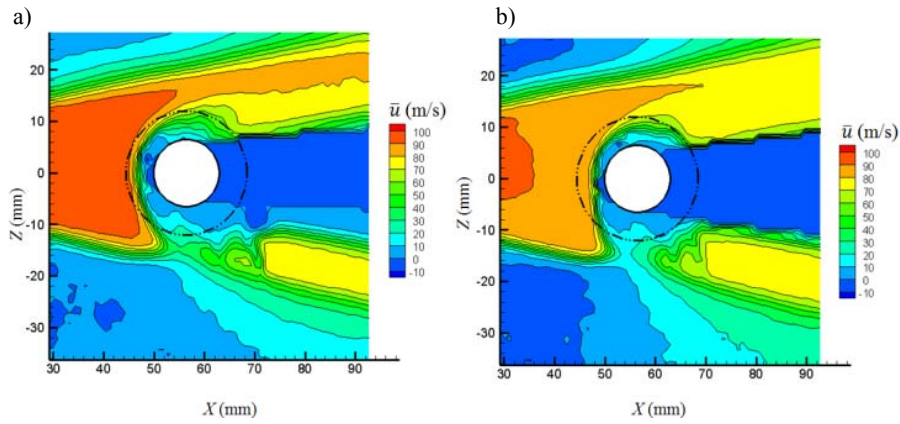

Fig. 8. Velocity distribution fields  $\bar{u}$  of particles moving in: water jet (a) and suspensive abrasive-water jet (b). Work conditions:  $p = 50$  bar,  $SoD = 60$ mm, garnet #200

Specific confirmation of such behavior are the pictures illustrating distribution fields of velocity  $\bar{w}$ , occurring inside water- (a) and abrasive-water jet (b), examined also in perpendicular direction  $Z$  (Fig. 9).

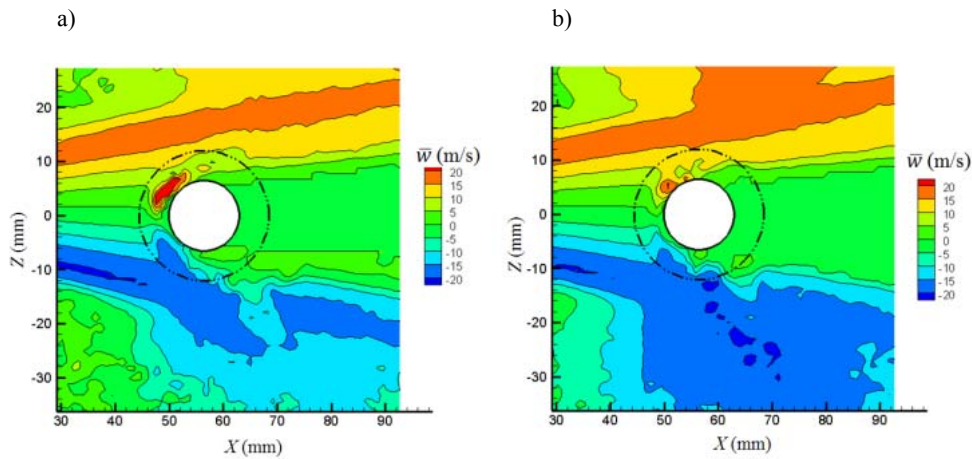

Fig. 9. Velocity distribution fields  $\bar{w}$  of particles moving in: water jet (a) and suspensive abrasive-water jet (b). Work conditions:  $p=50$  bar,  $SoD=60$ mm, garnet #200

In this particular case given for a jet's perpendicular direction to the axis (i.e. spreading in direction  $Z$ ), one may recognize a so-called ricochet jet bouncing from the rod surface representing the target there, which is also why field velocities of the jet are definitely lower. The discussed types of jet (a, b) cause maximum velocity values not exceeding 20 m/s.

Such dispersal of the jet's energy in the contact zone with the target material may be used. Looking for an analogy to practical conditions occurring inside a mill, it may be easily pointed out that solid particles carried in the jet collide with each other and with the internal cylindrical parts of the tube-shaped walls of the mill's work chamber, causing additional comminution of these particles. Taking everything into consideration, the information gathered during the research, illustrating the real proportions of the jet energy spreading in this model setup, may be transferred into real construction of the mill, and is helpful for its optimization.

## CONCLUSION

Thanks to experimental simulations realized with the help of a unique research position, it was possible to analyze the dynamical stages occurring inside a water jet droplet as well as in small particles of solid materials, moving along respective cross-sections of an abrasive-water jet.

The simulations conducted here were planned so that the materials used represented real copper ore particles comminuted in a jetting mill. Thanks to that, one can also eliminate the technological differences in the parameters used, e.g. relatively low water pressure ( $p = 50$  MPa), limiting the suspensive ASJ jet (including garnet #200) to a velocity exceeding 100 m/s.

Application of the mathematical methods in the research, elaborated and adopted for Koncerto2 software as well as for algorithms enabling definition of instantaneous velocity fields of the jet, allowed the conducting of a simulation analysis of the dynamism of both water-air- and abrasive-water jets.

Such dispersal of the jet energy in the contact zone with target material may be used practically. Looking for an analogy to practical conditions occurring inside the mill, it may be easily pointed out that solid particles carried in the jet collide with each other and with the internal cylindrical parts of the tube-shaped walls of the mill's work chamber, causing additional comminution of these particles. Taking it all into consideration, the information gathered during the research, illustrating the real proportions of the jet's energy spreading in this model setup, may be applied to the real construction of a mill, and is helpful for its optimization.

## BIBLIOGRAPHY

- BIELECKI M., 2013. The research of high-pressure water jet mill's parameters influence on different minerals comminution efficiency. Doctoral dissertation. Mechanical Dept., Technical University of Koszalin, 2013 (In Polish).
- BORKOWSKI P., 2010. Basis of high-pressure jetting Technologies. Monograph book of Institute of Unconventional Jetting Technologies, No. 174 (ISSN 0239-7129), 2010 (in Polish).

- BORKOWSKI P., BORKOWSKI J., 2009. Comminution of different materials with high-pressure water jet. *Unconventional and HydroJetting Technologies. Monograph of UHJT Institute (ISSN 0239-7129)*, Koszalin, 2009. pp. 493-500.
- BORKOWSKI P., BORKOWSKI J., 2010. Coal comminution with high pressure water jet. In book F. H. Trieb (editor), *Water Jetting (ISBN: 978 1 85598 121 8)*. BHR Group Ltd. UK, pp. 141-146.
- BORKOWSKI P., BORKOWSKI J., BIELECKI M., 2012. Coal disintegration using high pressure water jet. *Technical Gazette. Volume 19, No. 2, 2012*, pp. 367-372.
- BORKOWSKI P., BORKOWSKI J., BIELECKI M., 2014. Micronization of brittle materials with hydro-jetting method. *Mechanik, Nr 9/2014, s. 73-76/721 (in Polish)*.
- BORKOWSKI P., BORKOWSKI J., BIELECKI M., 2014. Micronization of Carbonate Copper Ore With High-Pressure Water Jet Method. *22nd International Conference on Water Jetting 2014 Advances in Current and Emerging Markets*. Edited by: M. Fairhurst. Netherlands, 2014, pp.305-314 (ISBN 978-1-85598-143-0)
- BORTOLUSSI A., CICCUCI R., KIM W.M., 1994. A waterjet mill for coal grinding. *Proceedings of the Int. Conf. Geomechanics 93*. Rakowski (ed.), Rotterdam: Balkema, 1994, str. 277-285.
- CUI L., AN L., GONG W., 2006. Optimizing process parameters of high pressure water jet mill. *The 8th Pacific Rim International Conference on Water Jet Technology*. China, 2006, pp. 138-145.
- CUI L., AN L., JIANG H., 2008. A novel process for preparation of ultra-clean superfine coal-oil slurry. *Fuel 87 (2008)*, str. 2296-2303.
- DVORSKÝ R., SLÍVA A., LUŇÁČEK J., PIKSOVÁ K., 2010. Preparation of silicon nanoparticles by means of disintegration in a cavitation water jet. *Proceedings of the 2nd Int. Conf. NANOCON 2010*, Ostrava: Tanger Ltd., str.144-150.
- FANG M., GONG W., CHEN Y., 1999. A new type of high pressure water jet mill. *10th American Waterjet Conference. WJTA 1999*, paper 31.
- FU S., ZHU Q., DUAN X., 2007. Experimental study on ultrafine comminution of minerals by thermally assisted high pressure water jet. *Journal of Beijing University of Technology*, 33, 12(2007), str. 1257-1261+1266
- GALECKI G., MAZURKIEWICZ M., 1988. Coal comminution by high-pressure water jets, machine-design conceptual study. *Abstracts of Papers of the American Chemical Society. Vol. 196, pages 99-fuel (1988)*.
- GEVECI M. et al., 2003. Imaging of the self-excited oscillation of flow past a cavity during generation of a flow tone. *Journal of Fluids and Structures*, 18(2003), pp. 665–694.
- ITO H., AOYAMA T., PENG G., SHIMIZU S., 2009. Observations of cavitating jets issuing from a sheathed nozzle. *9<sup>th</sup> Pacific Rim International Conference on Water Jetting Technology*. Japan, 2009. pp. 97-100.
- ITO H., PENG G., SHIMIZU S., 2011. Submerged abrasive suspension jets issuing from sheathed nozzle with ventilation. *2011 WJTA-IMCA Conference and Expo. USA, 2011, Paper E-2*.
- MAZURKIEWICZ M., 2001. Method of creating ultra-fine particles of materials using a high-pressure mill. *US patent No. 6,318,649, November 20, 2001*.
- MAZURKIEWICZ M., DAVE C., 2002. High pressure liquid jet mill for creating ultra-fine particles of materials. *Proceedings of the 16th Int. Conf. on Water Jetting*. Paul Lake ed., Cranfield, Bedfordshire UK: BHR Group Limited, str. 547-554.
- MAZURKIEWICZ M., VAŠEK J., 2009. Coal disintegration by high pressure waterjets-coal concept evaluation. *Proceedings of the 5th Southern Hemisphere Meeting on Mineral Technology*. Argentina, 1997, str. 9-12.

- NEIKOV O.D., 2009. Mechanical Crushing and Grinding, Handbook of Non-Ferrous Metal Powders. Technologies and Applications, pp. 47 – 62.
- PENG G., SHIMIZU S., FUJIKAWA S., 2009. Numerical simulation of high-speed water jet flow with cavitation by a compressible mixture flow model. 2009 American WJTA Conference and Expo.USA, Paper 4C.
- PENG G., SHIMIZU S., FUJIKAWA S., 2009. Numerical simulation of Turbulent Cavitating Water Jets Issued from a Submerged Orifice Nozzle. 9<sup>th</sup> Pacific Rim International Conference on Water Jetting Technology. Japan, pp. 139-144.
- SHIMIZU S., 2006. Structure and erosive characteristics of water jet issuing from fan jet nozzle.18th International Conference on Water Jetting, Poland, pp 337-345.
- SHIMIZU S., ADACHI H., IZUMI K., SAKAI H., 2007. High-speed observations of submerged water jets issuing from an abrasive water jet nozzle. 2007 American WJTA Conference and Expo, USA, Paper 4-H.
- SHIMIZU S., ISHIKAWA T., SAITO A., PENG G., 2009. Pulsation of abrasive water-jet. 2009 American WJTA Conference and Expo. USA, Paper 2-H.
- SHIMIZU S., ITO H., HORI S., PENG G., 2012. Abrasive suspension jet issuing from a fan jet nozzle. 21st International Conference on Water Jetting Looking to the future, learning from the past. BHR Group Ltd. Canada, pp. 395-403.
- SHIMIZU S., NISHIYAMA T., 2004. A sheathed nozzle for abrasive water suspension jets in submerged environments. 17th International Conference on Water Jetting. BHR Group Ltd., Germany, pp. 197-204.
- SHIMIZU S., SAKUMA M., HITOMI K., PENG G., 2010. Submerged cutting by abrasive suspension jet issuing from sheathed nozzle with ventilation. 18th International Conference on Water Jetting. BHR Group Ltd., Austria, , pp. 435-441.
- SHIMIZU S., SHINODA Y., PENG G., 2008. Flow characteristics of water jet issuing from a fan jet nozzle. 19th International Conference on Water Jetting. BHR Group Ltd., UK, pp. 55-65.
- SHIMIZU S., SUZUKI T., PENG G., 2014. Material removal characteristics of an abrasive fan jet. 22nd International Conference on Water Jetting. BHR Group Ltd., Netherlands, pp. 215-221.
- SITEK L., FOLDYNA J., MARTINEC P., KLICH J., MAŠLÁŇ M., 2012. On the preparation of precursors and carriers of nanoparticles by water jet technology. Technical Gazette 19, 3(2012), 465-474.

