

*Received February 22, 2017; reviewed; accepted August 4, 2017*

## **RESEARCH ON VERTICAL CHANGE TREND OF ENVIRONMENTAL INDICATORS OF MINING FACE AND ITS ASSESSMENT IN GOLD MINE**

Yang CAO<sup>\*</sup>, Hongguang JI, Feng PEI

University of Science and Technology Beijing, Beijing, China

**Abstract:** This paper presents interpretation of results of a series of monitoring tests on O<sub>2</sub>, CO<sub>2</sub>, dust, noxious gases, microclimate, noise and illumination, conducted in seven mining faces of a metal mine, with vertical depths of -30 m, -70 m, -110 m, -150 m, -190 m, -230 m and -300 m. Through research on a vertical trend of a particular factor, several findings can be concluded as follows: concentration of CO<sub>2</sub> rises up, while O<sub>2</sub> decreases with deeper mining depth; concentrations of noxious gases increase with the deeper mining depth; dust amount exceeds seriously the limit, and grows linearly with the mining depth; dry-bulb temperature, effective temperature and relative humidity demonstrate a linear increase with the mining depth; sound pressure level in mining faces seriously exceed the limit value, and may cause a great harm to miners; illumination values in most mining faces are lower, comparing to the standard. Comprehensive evaluation of environmental quality of faces is carried out by introducing a model of grey clustering combined with G1-method, to determine the weight values and classify quality of the working environment. Results reveal that the environmental quality grade (EQG) of mining faces decrease with the increasing depth. In particular, EQG is excellent when above -150 m exploitation level, at which it becomes mediocre, and changes to bad when below -150 m.

**Keywords:** *mining face; environmental indicators; change trend; gray cluster analysis; environmental quality grade*

### **INTRODUCTION**

The issues of underground working environment become worse and worse when excavations gradually transfer from open-pit to underground in a metal mine. Underground mining face is a confined space, which is easily polluted by toxic gases, dust

---

<sup>\*</sup> Corresponding author: [wwwcaoyang@126.com](mailto:wwwcaoyang@126.com) (Y. Cao)

or influenced by various hazardous factors. Deterioration of mining environment might bring about negative influences, which demonstrate in three aspects: 1) lower working efficiency of mining; 2) miners' health and safety get in danger; 3) an appearance of miners' unsafe behavior and psychological conditions, which could induce occurrence of accidents (Cao, et al., 2015; Cao, et al., 2016). Therefore, it is important to assess conditions of underground mining environment and put forward effective tactics, which makes a great importance in improving work efficiency, avoiding accidents and protecting miners' physical and psychological health. Investigations and surveys have been already conducted on distribution of noxious pollutants in underground metal mines (Zheng, et al., 2013; Zhang, et al., 2014). Fuzzy-advantage and disadvantage distance method has been adopted to analyze and assess dangerous factors in the underground mining environment in coal mine (Mahdevari, et al., 2014), while gray correlation assessment is applied to working environment of uranium ore and analyze the potential hazardous factors (Wang, et al., 2014). However, research on factor indicators changing with a depth is rarely carried out. Because of the connectivity of the mining system, mining environment may change as the depth of the metal mine increases. Geological environment, transfer of a mining face and migration of miners and equipment in excavations may result in variations of environmental factors in vertical direction with the increasing exploitation depth. Through several monitoring experiments conducted at mining faces at depths of -30 m, -70 m, -110 m, -150 m, -190 m, -230 m and -300 m in Guilaizhuang Gold Mine in Shandong Province, China, this paper presents analysis of the variation trends of environmental factors changing with exploitation level, and provides an evaluation of the comprehensive environmental quality in the mining faces. This provides valuable reference, which can be used to eliminate hazardous factors in working environment and safeguard the miners' safety and health.

Guilaizhuang Gold mine is located in Shangdong Province, China. This gold mine has begun to exploit for more than 40 years ago. In the beginning, the exploitation method is open-pit mining, and then change into underground mining method because of limit of pit bottom, which can be seen from the figure 1. Currently, there are more than 7 exploitation levels, which connecting the shafts and ore body. Monitoring tests on O<sub>2</sub>, CO<sub>2</sub>, dust, toxic gases(CO, NO<sub>x</sub>, SO<sub>2</sub> and H<sub>2</sub>S ), dry-bulb temperature, relative humidity, noise and illumination are carried out in seven mining faces from seven respective mining depths (-30 m, -70 m, -110 m, -150 m, -190 m, -230 m and -300 m). The mining face is designed similarly as rock drift for gold ore and adopted to paste backfilling technology after abstraction. The schematic map of mining face in Guilaizhuang Gold Mine can be observed in figure 2.

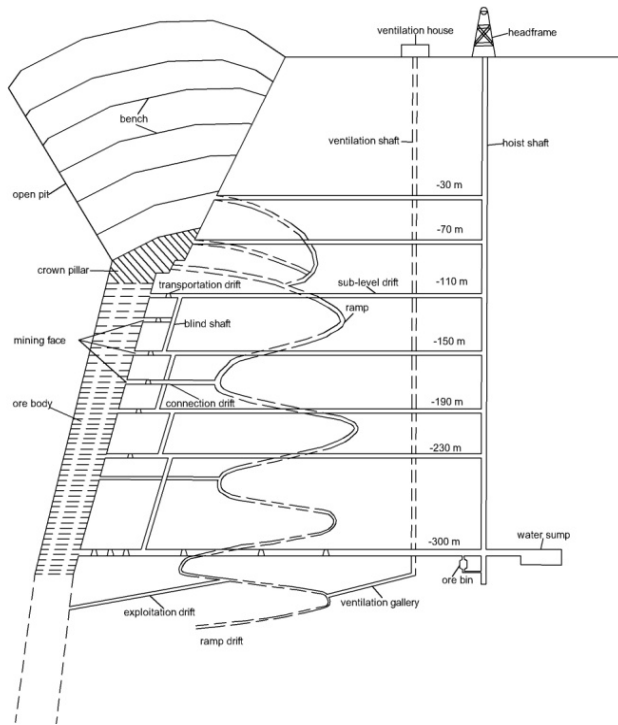

Fig. 1. Profile map of Guilaizhuang Gold Mine in Shangdong Province

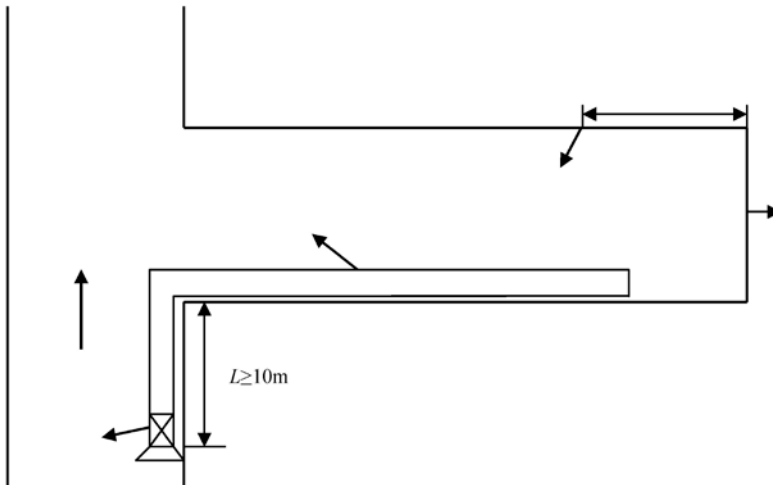

Fig. 2. Schematic map of mining face

## ANALYSIS ON CHANGE TRENDS OF INDICATORS OF MINING FACE

### RESPIRATORY GASES

Oxygen and carbon dioxide are generally regarded as respiratory gases. When human body is exposed to an environment with a low concentration of  $O_2$ , it undergoes a series of harmful medical reactions, which in extreme cases may cause death. When the concentration of  $CO_2$  is too low or too high in the air, it may be harmful, because it affects human body's respiration. According to the safety regulations of metal and non-metal mines in China, concentration of  $O_2$  in the air should not be lower than 20 vol.% and concentration of  $CO_2$  should not be higher than 0.5 vol.%. It is known that there are numerous steps related to a consumption of  $O_2$  and production of  $CO_2$  in the mining cycle, which result in a varying concentrations of  $O_2$  and  $CO_2$  at the mining faces. The respective concentrations of oxygen and carbon dioxide in the considered seven mining faces have been monitored in the gold mine. Relevant results are shown in the figure 3.

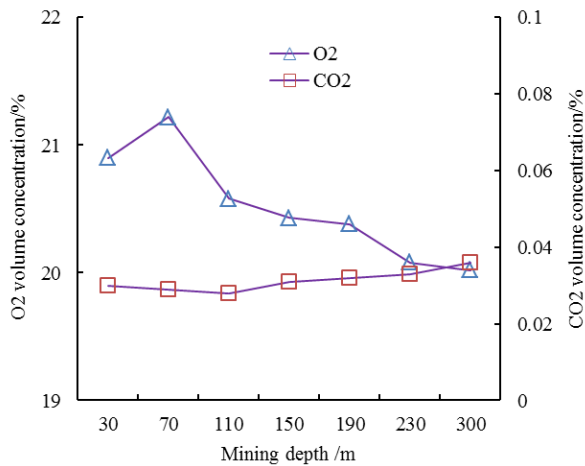

Fig. 3. Changes of concentration of  $O_2$  and  $CO_2$  with exploitation depth in the gold mine

As shown in figure 3, as the exploitation depth increases, concentration of  $O_2$  in the seven tested faces increases firstly, and then gradually decreases. As oxygen consumption rises along the airflow, such decrease is expected, and it turns out that  $O_2$  concentrations in most of tested faces were lower than 20.9 vol.%, which should be noted. Meanwhile,  $CO_2$  concentration in seven mining faces decreases firstly, and then gradually increases, however, the values are not higher than 0.5 vol.%. The observed increase of  $CO_2$  level can be related to the decreasing concentration of  $O_2$ , but the

results indicate that consumption of O<sub>2</sub> and production of CO<sub>2</sub> in the airflow proceed slowly, so the process of ventilation is satisfactory down to the -300 m exploitation depth.

DUST AND TOXIC GASES

Dust does harm to miner’s immune system and respiration tract. It may also contribute to miner’s silicosis or even lung cancer. However, noxious gases, such as CO, NO<sub>x</sub>, SO<sub>2</sub> and H<sub>2</sub>S, can damage organs or even cause death when their concentration exceeds exposure limit values. There are explicit regulations about such exposure limit values, which are gathered in table 1. The concentrations of dust and toxic gases in seven tested mining faces were monitored, and the related data are shown in figure 4 and figure 5.

Table 1. Limits of dust and noxious gases in mining face

Items	MAC/mg•m <sup>-3</sup>	PC-TWA/mg•m <sup>-3</sup>	PC-STEL/mg•m <sup>-3</sup>
CO	-	20	30
NO <sub>2</sub>	-	5	10
NO	-	15	-
SO <sub>2</sub>	-	5	10
H <sub>2</sub> S	10	-	-
Dust	0.5	-	-

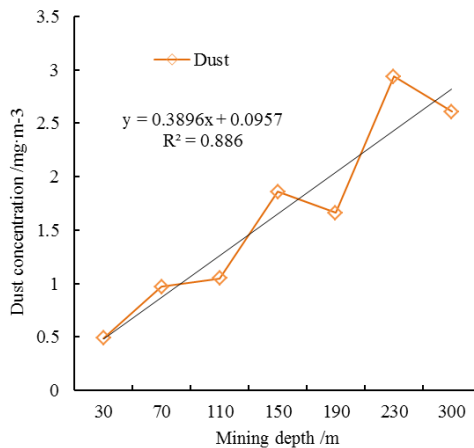

Fig. 4. Change trend of concentration of dust with the mining depth

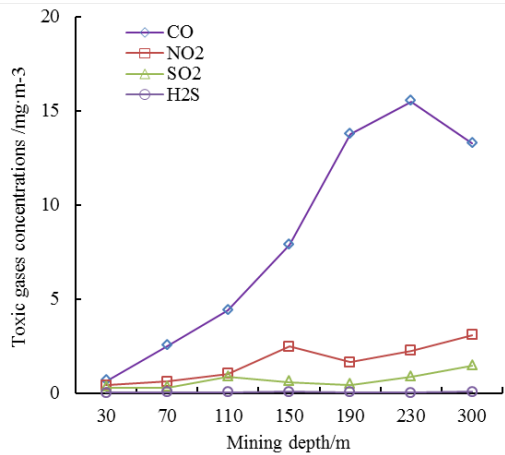

Fig. 5. Change trend of concentration of noxious gases with the mining depth

As presented in figure 4, concentrations of dust in seven tested mining faces increase as the mining depth goes deeper. There is a strong linear relationship between that concentration and the depth. Also, only the -30 m tested mining face has a dust concentration lower than  $0.5 \text{ mg}\cdot\text{m}^{-3}$ , while for all other faces the standard value is exceeded. The high concentrations of dust may be closely related to low-efficient dust-fall measures and inadequate ventilation in this aspect. In figure 5, the concentrations of CO, NO<sub>2</sub> and SO<sub>2</sub> can be found to rise as the mining depth increases, while the concentration of H<sub>2</sub>S remains almost at the same level. Among those toxic gases, amount of CO was found to increase the most, and the concentrations of NO<sub>2</sub> and SO<sub>2</sub> increase in a relatively more linear manner. It should be noted that H<sub>2</sub>S remains in a low concentration, and the concentration of all four gases, CO, NO<sub>2</sub>, SO<sub>2</sub> and H<sub>2</sub>S are never higher than the exposure limits given in table 1. As the excavations go deeper, rise of CO and NO<sub>2</sub> concentrations indicate that fresh airflow in the mine is polluted (airflow disorder, recirculating and string airflow). Meanwhile, ventilation's capability of dispersing pollutions gradually decreases, as the complexity and resistance of the ventilation system rise. SO<sub>2</sub> and H<sub>2</sub>S are in low concentrations, and the gases mostly come from equipment exhaust and the oxidation of sulfur-bearing minerals. Due to their random discharge, SO<sub>2</sub> and H<sub>2</sub>S can be kept at low levels.

#### TEMPERATURE AND HUMIDITY

Poor ventilation in the mining spot will trigger imbalances between temperature, humidity and airflow speed, which will lead to a high temperature and a high relative humidity in the mining site. Miners in such environment will suffer from an increased body temperature and increased heart rate. It may result in a sunstroke condition and even death, threatening workers' health and safety, as well as affecting the digging

efficiency. In China it is regulated in the safety code of metal and nonmetal mines that micro-climate conditions in the mining operation should be in accordance with the standards, as presented in table 2. Otherwise, cooling or other prevention measures should be taken. The airflow speed, relative humidity and dry-bulb temperature in seven testing sites have been monitored and recorded. Results are shown in figure 6 and figure 7.

Table 2. Microclimate condition values in mining site

Dry-bulb temperature/ °C	Relative humidity/%	Airflow speed/m*s <sup>-1</sup>	Remark
≤28	none	0.5-1.0	Top limit
≤26	none	0.3-0.5	Proper
≤18	none	≤0.3	Warm cloth

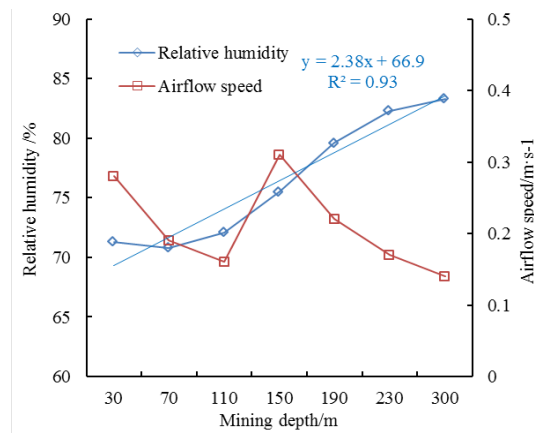

Fig. 6. Change trend of relative humidity with mining depth

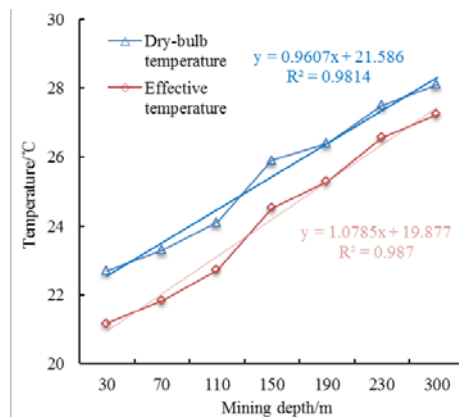

Fig. 7. Change trend of temperature with mining depth

It is possible to derive from the figure 6 that as the mining depth increases, relative humidity in the seven testing sites also increases, and there is a linear relationship between them. Relative humidity in most of the testing sites is over 70%, which may make miners feel uncomfortable. From figure 7 it can be noticed that the dry-bulb temperature rises as the mining depth goes deeper. Dry-bulb temperature in most of the tested sites is over 26°C, and there is a linearity between them. Therefore, it can be stated that heat and humidity issues worsen as the mining depth goes deeper. The air-flow speed is small and unstable in the tested mining sites, which may contribute a lot to high temperature and humidity. Given that the temperature, relative humidity and airflow speed, Fushun Institution put forward an equation of effective temperature (Yang, et al., 2009):

$$T_z = T_D - 4.356(1 - H_R) - v \quad (1)$$

where:  $T_z$  is the effective temperature (°C);  $T_D$  is the dry-bulb temperature (°C);  $H_R$  is the relative humidity;  $v$  is the airflow speed (m/s).

As it can be noticed from figure 7, with mining depth going deeper, the effective temperature in the mining spots increases, and there is also a linear relation observed. The effective temperature gradient is 1.08, which is slightly higher than the dry-bulb temperature gradient of 0.96. Therefore, one can tell that humidity and wind speed contribute to the effective heat, and as the depth of mining rises, both will have greater contribution. Dry-bulb temperature and effective temperature fitting lines intercept y-axis at respectively 21.6 and 19.9, indicating that low temperature could be to some extent lower than the effective temperature of the mining environment. In general it can be stated that as the mining depth goes deeper, the heat and humidity issues will become more and more prominent.

#### NOISE AND ILLUMINATION

Noise created by the mining process is of great significance to workers' safety, health and work efficiency. Noise may impair their hearings and create negative impact on the central nervous system, cardiovascular system and digestive system (Shao, et al, 2011). In addition, it will also distract workers' attention, affect their emotion and cause their fatigue. Noise can also block information transfer in the mining site and trigger accidents. It is regulated in the safety code of metal and nonmetal mines that the health value of noise, to which the workers are being exposed for 8 hours, should be 85 dB, and the highest allowed value should be 115 dB. However, the sound pressure level (SPL) and lasting hours of the noise in each link of the digging may be different. It will be more reasonable to adopt equivalent level to present the noise level in the mining sites. And the calculative equation of the equivalent level of noise can be written as follow (Wu, et al, 2011):



$$L_{eq} = 10 \lg \frac{\sum_i 10^{\frac{L_i}{10}} t_i}{\sum_i t_i} \tag{12}$$

After calculation of the equivalent sound level of the seven tested mining spots (8 hours), the results could be presented in the following table 3.

Table.3. SPL and illumination values

Mining depth / m	SPL / dB	Illumination / lx
30	113.08	5.53
70	111.54	5.61
110	110.43	3.89
150	112.04	4.45
190	115.79	3.68
230	109.07	3.93
300	108.81	5.11
Average	111.54	4.6

From table 3, it can be concluded that in the seven tested mining faces the equivalent sound level exceeds the 8 hour limited value (85 dB). The equivalent noise value in -190 m mining face is 118 dB, which also surpasses the highest allowed value (115dB), and approaches human hearing pain threshold (120 dB). Such high value indicates that noise in this mining face threatens miners’ safety and health. The appearance of the high-level and lasting noise can originate from drilling, ventilation and removal of muck pile. Also, noise of different sound levels and different sources may be reflected and refracted in the tunnel creating “overlapped” noise of higher level, which could expose miners to potential harm. Obviously, noise should be controlled strictly to avoid occupational diseases and damage to workers.

Insufficient illumination will not only reduce working efficiency, but also cause fatigue to visual organs, and even may cause accidents. Illumination must be present in the underground mining sites, but no reference values in the Chinese regulations can be found. However, illumination value of the mining face should not be less than 5 lx (Peng, 2006). Although the value is affected by type and power of lamp, interval distance between the lamps and the volume of the mining faces, the maximum illumination of a lamp should be in the vertical location from the ground, and this value would be decreased with an increase of a distance between lamp and the location. The maximum illumination values in the seven tested mining faces have been measured, as demonstrated in Fig. 6. The values in four tested mining faces are found to be lower than 5 lx, and the average value of maximum illumination is lower than 5 lx as well,

which indicates that the entire lighting conditions in the considered mining faces are bad. Illuminating conditions in this particular mine need further improvement.

## ASSESSMENT OF COMPREHENSIVE ENVIRONMENT IN MINING FACE

Currently, there are some models and methods applied to assess the quality of mining environment, such as index assessment, level analysis method, fuzzy mathematical theory and rough set theory. Those methods, however, exhibit several drawbacks. For example, index assessment is considered as too simple, and not comprehensive, level analysis method and fuzzy mathematical theory are partly subjective for their lack of measuring standard of theoretical accordance. Furthermore, rough set theory applies to uncertain systems of fuzzy boundary, and its application to the assessment of mining faces requires further discussion. Meanwhile, most surveys focus on assessment of pollution conditions in mine areas (Jiao, et al., 2016; Gu, et al., 2014 ), coal mine conditions (Sun, et al., 2016; Tang, et al., 2010) and human comfort in mines (Wang, et al., 2015; Na, et al., 2015; Wang, et al., 2012 ), while few studies are devoted to the comprehensive assessment of the underground metal mine environment. Assessment of such environment can be regarded as a typical theoretical issue of gray system method, with the characteristics of little data and barren information (Li, et al., 2007; Liu, et al., 2007). Based on the investigations and surveys of changing trends of environmental factors in mining faces, this method can help to obtain a more objective and reasonable results.

### SELECTION OF ENVIRONMENT INDICATORS

The mining environment is the comprehensive reflection of multiple indicators, which includes O<sub>2</sub>, CO<sub>2</sub>, dust, toxic gases (CO, NO<sub>x</sub>, SO<sub>2</sub>, H<sub>2</sub>S), integrated temperature (wind speed, temperature and humidity), noise sound level and illumination. It is beneficial and convenient for the assessment if some simplification and pre-calculation is applied to these environmental indicators. For instance, simplified calculation is obtained for the next modeling through introduction of the effective temperature indicator measuring the wind speed, temperature and humidity of the mining sites, as well as through adoption of Nemerow index to integrate four toxic gases (CO, NO<sub>x</sub>, SO<sub>2</sub> and H<sub>2</sub>S) into one indicator (N.L. Nemerow, 1974). Specific equation for such simplifying is shown as follows:

$$I = \sqrt{\frac{\left[ \max \frac{c_i}{s_i} \right]^2 + \left[ \frac{1}{n} \sum_{i=1}^n \frac{c_i}{s_i} \right]^2}{2}} \quad (3)$$

where:  $I$  is the quality assessing index;  $c_i$  is the volume percentage of  $i^{\text{th}}$  gas ( $10^{-6}$ );  $s_i$  is the health standard of  $i^{\text{th}}$  gas ( $10^{-6}$ ).

The indicators and monitoring values of mining environment quality for the conducted assessment are shown in the figure 8 and table 4.

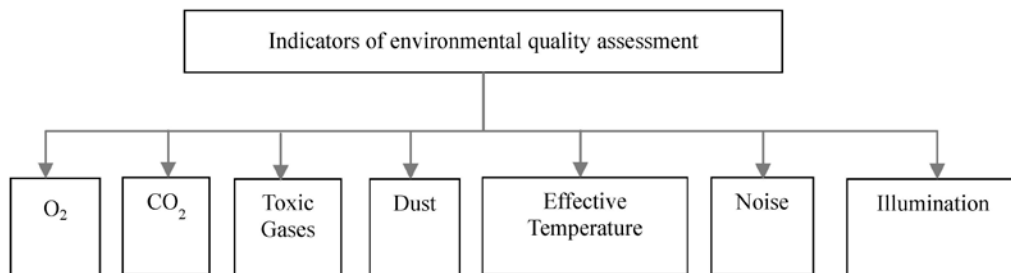

Fig. 8. Indicators of environmental quality in mining face

Table 4. Observation values of environmental indicators in mining face

Indicator Depth	O <sub>2</sub> %	CO <sub>2</sub> %	Dust mg/m <sup>3</sup>	Toxic gas index -	Effective temperature °C	SPL dB	Illumination lx
-30 m	20.90	0.030	0.49	0.09	21.2	113.08	5.53
-70 m	21.22	0.029	0.97	0.13	21.8	111.54	5.61
-110 m	20.58	0.028	1.05	0.22	22.7	110.43	3.89
-150 m	20.43	0.031	1.86	0.52	24.5	112.02	4.45
-190 m	20.38	0.032	1.66	0.38	25.3	115.79	3.68
-230 m	20.08	0.033	2.94	0.52	26.6	109.07	3.91
-300 m	20.02	0.036	2.61	0.67	27.2	108.81	5.11

#### ENVIRONMENTAL QUALITY GRADE OF MINING FACE

In order to assess the comprehensive environmental quality in mining face and then classify, it is inevitable to select the indicators reflecting environmental condition and classify single indicators in terms of specific values. In particular, seven indicators (O<sub>2</sub>, CO<sub>2</sub>, dust, toxic gases index, effective temperature, SPL and illumination) are chosen as the assessing elements. The quality grade of the mining environment could be obtained through related standards and regulations and was divided into four levels (excellent, good, general, bad) to judge the comprehensive environment quality of the mining face as can be seen from the table 5.

Table 5. Evaluation classification of environmental indicators in mining face.

Indicator \ Grade	Excellent	Good	General	Bad
O <sub>2</sub> (%)	20.9 < x ≤ 22	19.5 < x ≤ 20.9	18 < x ≤ 19.5	x ≤ 18
CO <sub>2</sub> (%)	0 < x ≤ 0.03	0.03 < x ≤ 0.5	0.5 < x ≤ 1	1 < x
dust(mg·m <sup>-3</sup> )	0 < x ≤ 0.25	0.25 < x ≤ 0.5	0.5 < x ≤ 1	1 < x
Toxic gas index	0 < x ≤ 0.5	0.5 < x ≤ 1	1 < x ≤ 1.5	1.5 < x
Effective temperature (°C)(summer)	16 < x ≤ 25	25 < x ≤ 28	28 < x ≤ 30	30 < x
SPL (dB)	0 < x ≤ 55	55 < x ≤ 85	85 < x ≤ 115	115 < x
Illumination(lx)	75 < x ≤ 100	20 < x ≤ 75	5 < x ≤ 20	0 < x ≤ 5

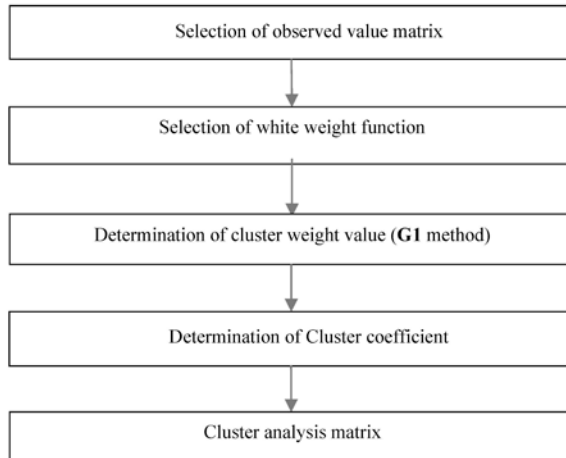

Fig. 9. Scheme of process of gray cluster analysis

### GREY CLUSTER ANALYSIS MODEL

Gray cluster analysis is useful method in the gray theories, which allows to calculate the cluster coefficients through white function, to test whether the observed objects belong to the presetting level. It can be proceeded as the following steps: 1) Matrix of observed values: determine the index factors and quality levels of the mining environment to form the observed values matrix; 2) Determination of the white weight function: calculate the white weight function of the quality level ranges corresponding to the index factors; 3) Determination of the cluster weight: calculate the weight of

each index factors; 4) Determination of the cluster coefficient: derive the selected  $k$  corresponding to the biggest cluster coefficient as the gray value, by calculating the gray cluster coefficients of the observed values to realize the cluster. The procedure of gray cluster analysis can be found in figure 9.

In the model of gray cluster analysis it is necessary to give weight value to indicators, because some indicators have differences in the meanings of indexes, dimensions and the observed values. **G1** method is introduced, because it does not require construction of a judgment matrix or conduction of consistency test (Guo, 2007). There is no limit for the element numbers in the same level, which is characterized by simple calculation and application. The steps of the method are shown in figure 10.

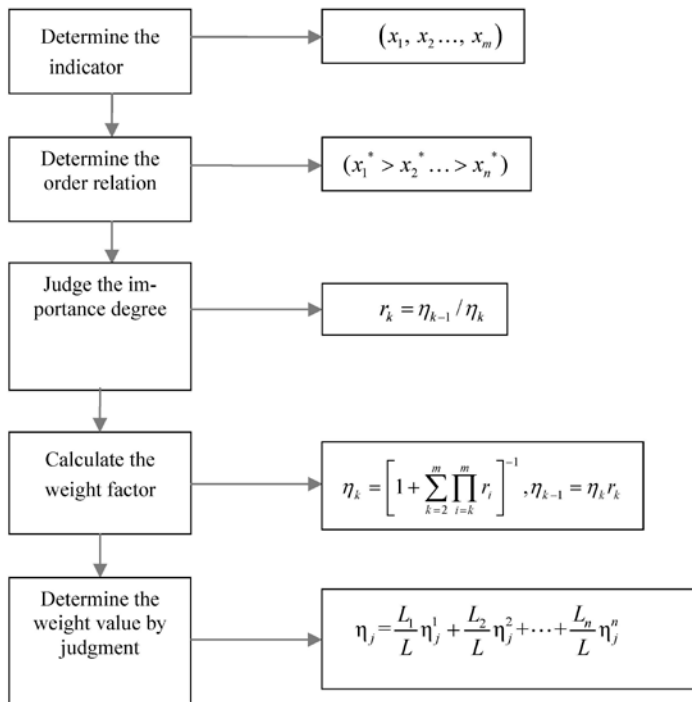

Fig. 10. Scheme of calculation process of G1 method

According to G1 method, an evaluation questionnaire is designed, based on index factors of the mining environment and given to directors, managers, safety guards and miners to rank the indicators. In this way, the weight values of indexes are obtained from participants according to skills, knowledge and experience. The weight values of indicators are obtained and shown in table 6. It can be concluded that the weight factor of the effective temperature is the biggest of all, indicating that it is also the most influential index in all selected indicators. Noise is the second most important indicator,

with a weight value of 0.189. Illumination has the lowest weight value, meaning it is the least important among all the indicators. Although the results include subjective opinions and personal experience, it is still useful and applicable as an instruction of assessing the environment quality grade in mining faces.

Table 6. Weight values of environmental indicators of mining face

Indicators	O <sub>2</sub>	CO <sub>2</sub>	Dust	Toxic gas	Effective temperature	Noise	Illumination
Weight value	0.179	0.084	0.166	0.123	0.192	0.189	0.067

CLUSTER ANALYSIS IN COMPREHENSIVE ENVIRONMENT

Through the gray cluster analysis model, cluster coefficient matrix can be calculated as follows:

$$\sum = (\sigma_i^k) = \begin{matrix} & \begin{matrix} \text{Excellent} & \text{Good} & \text{General} & \text{Bad} \end{matrix} \\ \begin{matrix} -30 \text{ m} \\ -70 \text{ m} \\ -110 \text{ m} \\ -150 \text{ m} \\ -190 \text{ m} \\ -230 \text{ m} \\ -300 \text{ m} \end{matrix} & \begin{bmatrix} 0.895 & 0.753 & 0.271 & 0.000 \\ 0.844 & 0.703 & 0.473 & 0.000 \\ 0.322 & 0.686 & 0.512 & 0.208 \\ 0.227 & 0.234 & 0.581 & 0.459 \\ 0.101 & 0.328 & 0.450 & 0.515 \\ 0.119 & 0.217 & 0.349 & 0.546 \\ 0.093 & 0.201 & 0.401 & 0.607 \end{bmatrix} \end{matrix}$$

According to the rule of cluster coefficient matrix, the row where the maximum value of cluster coefficient in each line can be described as the environmental grade for mining depth. For example, for -30m mining depth, the maximum value of cluster coefficient is **0.895**, and the corresponding row is “excellent”, which means that the environmental quality grade in tested mining face of -30 m depth is “excellent”. Therefore, the cluster coefficient and environmental quality grade of the seven tested mining faces are shown in the table 7.

Table 7. Evaluation results of comprehensive environment quality of mining faces

Mining face	-30 m	-70 m	-110 m	-150 m	-190 m	-230 m	-300m
Cluster coefficient	$\sigma_1^1=0.895$	$\sigma_1^1=0.844$	$\sigma_3^2=0.686$	$\sigma_4^3=0.581$	$\sigma_5^4=0.515$	$\sigma_6^4=0.546$	$\sigma_7^4=0.607$
Environmental quality grade	Excellent	Excellent	Good	General	Bad	Bad	Bad

As can be seen in Tab. 7, comprehensive environment quality in the tested mining faces decreases, as the mining depth goes deeper. Comprehensive environmental quality in -150 m mining face has a general grade. Three mining faces of -30 m, -70 m and -110 m have excellent or good grade of environmental quality, while other three mining sites of -190 m, -230 m and -300 m have poor grade. It was found that noise in the mining sites greatly exceeds the standard, making the biggest impact on the quality of the environment. Impacts of dust and illumination on the environmental quality rank in the second. The temperature and humidity issues have gradually become serious when mining depth exceeds 300 m. The concentrations of toxic gases remain lower than the exposure limits, which would not influence the environmental quality. It can be summarized that noise pollution is a serious problem, which needs to be solved as soon as possible. Temperature and humidity issues, which are becoming worse and worse with the increasing depth of mining, could be solved by better ventilation. These conclusions could provide references to launch control and protective measures of the mining environment.

## CONCLUSION

According to the results of cluster model analysis, we can find that the EQG of mining faces decrease when mining depth goes deeper. This means that the deeper exploitation miners are going to do, the worse environment miners are going to face. It gives a good remind of reinforcing the improvement of environment. In details, for the more and more serious environmental condition in mining face of Guilaizhuang Gold Mine, effective temperature, noise issue and oxygen are the top three problems, which the staffs in the gold mine care about the most. And then the dust and toxic gases are also comparatively alarming issues remaining to be solved. However, the results can provide us with good orientation to carry out daily safety work. For safe production in gold mine, ventilation is the most important of all. In term of current situation, it is necessary to enhance the capacity of main fan to increase the airflow in the shaft. The increasing airflow can not only offer sufficient oxygen for miners, but also compensate for the consumption of oxygen, eliminate the heat and moisture accumulation, dilute the toxic gases and blow away dust. For mining faces, it is indispensable to add auxiliary ventilator to pump more fresh air. For local ventilation network, some issues should be taken into consideration such as the airflow disorder in panel, circulation of airflow in mining face, serial connection between polluted airflow and fresh airflow, etc. Noise should be noticed that SPL values in tested mining faces in the gold mine generally exceed the exposure limit. Protective measures should be considered in two aspects: 1) soundproof technologies should be applied to the machineries, such as drills, ventilators, diesels; 2) hearing-protective measures should be given to miners, such as earplug, headset, sound eliminator cloth, etc. Generally, vibration issue gener-

ates along with the noise problem. Further research on vibration damage of miners is meaningful to carry out in the gold mine. Illumination condition in the mining face is not good enough and need to be improved. Higher-watt lighting should be used in the mining faces, and distance between lamps could be shorter so as to obtain better illumination condition in the mining faces.

#### ACKNOWLEDGEMENTS

*This study is funded by the project “The State Key Research Development Program of China (Grant No. 2016YFC0600801)”. Thanks to Guilaizhuang Gold Mine and the personnel for providing the valuable data.*

#### REFERENCE

- Cao Yang, Ji Hong-guang, You Shuang, Li Song, 2015 41(06). Research on mechanism of blasting fume poisoning and prevention technology[J]. Industrial Safety and Environmental Protection, 73-75.
- Cao Yang, Ji Hong-guang, You Shuang, Zhou Qiming, 2016 484(10). Research on casual-effect model of blasting accident and its application[J]. Metal Mine., 161-164.
- Zheng Jianjun, Wang Weizhong, Ren Zhong-han, 2013(6). Research on source and composition of the toxic and harmful gas and its influence factor in a certain gold deposit[J]. Metal Mining, 148-150.
- Zhang Ge, Li Lixia, Ji Hongguang 2014, 23(2). In situ investigation of gaseous pollution in the ramp of an underground gold mine[J]. Indoor and Built Environment, 293-298.
- SATAR Mahdevari, Kourosh Shahriar, Akbar Esfahanipour, 2014, 488(1). Human health and safety risks management in underground coal mines using fuzzy topsis[J]. Science of the Total Environment, 85-99.
- Wang Shuyun, Fang Jing, Kuang Ya, 2014, 24( 7). Improved grey relational evaluation model for working environment in uranium mines and its application[J]. China Safety Science Journal, 63-69.
- Yang Deyuan, Yang Tianhong. 2009Thermal environment in mine and its control, Beijing[M], China Metallurgical Industry Press.
- Shao Hui, Zhao Qingxian, Ge Xiukun, 2011. Safety psychology and behavior management. Beijing: Chemistry Industry Press.
- Wu Jiuhui, 2011 Noise Analysis and Control. Xi'an: Xi'an Jiaotong University Press,.
- Peng Zhiyuan. 2006. Practical handbook of safety technology for underground lighting and power supply in mine. Jilin: Jilin Electronic Press,.
- Jiao Lianming, 2016, 21(2). Evaluation of mine environment quality based on gray cluster analysis[J]. Coal Mining Technology, 78-82.
- Gu Ping, Shi Changxue, Chen Dong-xiao, 2014, 32(5). The method of integrated assessment of mine environmental impact based on fuzzy mathematics[J]. China Resources Comprehensive Utilization, 58-60.
- Sun Yujie, Wang Wenqing, 2016, 19(2). Comprehensive evaluation of mine environmental safety factors based on rough set[J]. Journal of Xi'an University(Natural Science Edition), 13-18.
- Tang Zhipeng, Yang Peng, Lv Wensheng, 2010, 32(3). Grey clustering evaluation of plateau underground working environment based on index pretreatment[J]. Journal of University of Science and Technology Beijing, 282-286.



- Wang Shu, Jin Longzhe, Ou Shengnan, 2015, 37(5). Prediction model of human comfort index in underground emergency refuge facilities[J]. Chinese Journal of Engineering, 551-555.
- Na Hanchu, Li Xibing, Ma Chunde, 2015, 15(4). Application of the modified AHP-fuzzy method to the assessment of the mining personal comfort degree[J]. Journal of Safety and Environment, 12-16.
- Wang Xiran, Li Xibing, Dong Long-jun, 2012, 22(2). Occupational hazard of high temperature and high humidity in mines and determination of critical prevention points[J]. China Saety Science Journal, 157-163.
- Li Xiaolu, Hu Nailian, Li Chun-lei, 2007, 27(5). Application of grey cluster analysis in evaluation of metal mines' underground working environment[J]. Ming Research & Development, 84-86.
- Liu Si-feng, Xie Naiming, 2007. Grey system theory and its application. Beijing: Science Press,.
- N.L. Nemerow, 1974. Scientific Stream Pollution Analysis. McGraw-Hill, New York.
- Guo Yajun, 2007. Theory and application of comprehensive evaluation method, Beijing: Science Press.